

SPANIT® WORK BRIDGE

GOMACO 1000 - 2000 - 4000 - 6000 SERIES

“ALL YOUR BRIDGING NEEDS”



- Bridges
- Streets
- Highways
- Flat Slabs
- Canals/Slopes
- Easy to Assemble
- Easy to Transport
- Versatile/Lightweight
- Reliable/Safe

GOMACO Spanit® Work Bridge available in 1000, 2000, 4000 and 6000 series

All GOMACO Spanit® insert sections within the same series are interchangeable. Easy assembly is assured through the use of pin-connected sections. Spanit® insert sections range in length from 2 ft. to 12 ft. (.61 to 3.66 m).

GOMACO Spanit® can be self-powered and is available with self-widening ends or a telescopic insert. A variety of Spanit® trolley options are available.



12 ft. (3.66 m) insert



3 ft. (.91 m) insert

1000 SERIES SPANIT® INSERTS

- 16 in. (406 mm) wide and 12 in. (305 mm) deep
- Insert sections available in 3 ft. (.91 m), 6 ft. (1.83 m) and 12 ft. (3.66 m) lengths



2000 SERIES SPANIT® INSERTS

- 3 ft. (.91 m) insert shown
- 24 in. (610 mm) wide and 18 in. (457 mm) deep
- Insert sections available in 3 ft. (.91 m), 6 ft. (1.83 m) and 12 ft. (3.66 m) lengths



Slope Wedges are designed for breaking bridge at top or bottom of slope.



2000 SERIES SPANIT® TELESCOPING INSERT

- Telescopes from 12 ft. (3.66 m) up to 18 ft. (5.49 m) with expanded metal decking



WHEELS FOR TROLLEYS

(Left to right photo identification)

1. Cupped wheel for 2 in. (51 mm) pipe
2. 3.25 in. (83 mm) double-flanged wheel for square tubing or forms
3. Urethane wheel

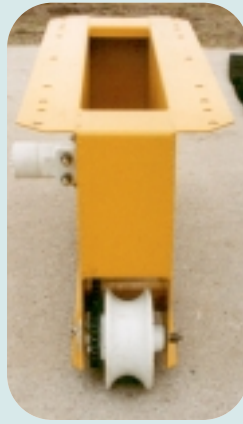

HYDRAULICALLY POWERED TROLLEY

(Mounts to 1000 & 2000 Spanit®)

- 3.25 in. (83 mm) wide double-flanged wheels or cupped wheels for 2 in. (51 mm) pipe or urethane wheels



NON-POWERED TROLLEYS

(Left to right photo identification)

1. Skewable and height adjustable trolley
2. Non-adjustable trolley
3. Rubber-tired trolley

(Rubber-tired trolley mounts to 1000, 2000 & 4000 Spanit® Adjustable, and non-adjustable trolleys mount to 1000 and 2000 Spanit®)



HYDRAULICALLY POWERED TROLLEY

(Mounts to 1000, 2000 & 4000 Spanit®)

- Equipped with rubber flotation tires

4000/6000 TROLLEY ASSEMBLY

- Four stationary jack mounts
- Four heavy-duty jacks with 19 in. (483 mm) stroke and manual adjustment of 4 to 16 in. (102 to 406 mm) are available
- Four idler trolleys



SELF-WIDENING ATTACHMENT

(Mounts on 4000 Spanit®)

- 10 ft. (3.05 m) of self-widening
- Includes 12 ft. (3.66 m) of self-widening rail
- Two each self-widening jack mounts
- Mounts to 12 ft. (3.66 m) section of Spanit®

(Does not include work bridge insert, heavy duty jacks or bogies)



SELF-WIDENING ATTACHMENT

(Mounts on 1000 & 2000 Spanit®)

- 10 ft. (3.05 m) of self-widening
- Includes 12 ft. (3.66 m) of self-widening rail
- Includes self-widening mount
- Mounts to 12 ft. (3.66 m) section of Spanit®

(Does not include work bridge or trolley)



HEIGHT ADJUSTERS

(Mount on 1000 & 2000 Spanit®)

- For drop-center bridging
- Height adjusters will drop center of bridging up to 30 in. (762 mm)



HEIGHT ADJUSTERS

(Mount on 4000 Spanit®)

- For drop-center bridging
- Height adjusters will drop center of bridging from 24 in. (610 mm) up to 42 in. (1067 mm)

POWER UNIT/CONTROL CONSOLE WITH OR WITHOUT CURE SYSTEM PLUMBING

(1000, 2000, 4000 and 6000 Spanit®)

- Self-contained operator's control console with 13 to 20 hp (9.7 to 14.9 kW) electric start gasoline or diesel engine
- Two-stage hydraulic pump
- 5.5 gal. (20.8 L) fuel reservoir and 13 gal. (49.2 L) hydraulic oil reservoir
- Directional and speed controls
- Cure system plumbing



TROLLEY CONFIGURATIONS

FOR THE 1000, 2000, 4000 AND 6000 SERIES SPANIT®

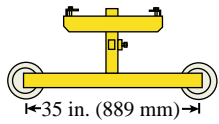

Dimension A - Height adjustable from approximately 16 in. (406 mm) up to 22 in. (559 mm), 26 in. (660 mm) up to 34 in. (864 mm) and 30 in. (762 mm) up to 38 in. (965 mm)

Skewable and height adjustable non-powered trolley, equipped with 3.25 in. (83 mm) wide double-flanged wheels or cupped wheels for 2 in. (51 mm) pipe or urethane wheels for the 1000 Series Spanit®

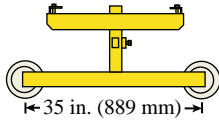

Dimension A - Height adjustable from approximately 16 in. (406 mm) up to 22 in. (559 mm) and from 30 in. (762 mm) up to 38 in. (965 mm)

Skewable and height adjustable non-powered trolley, equipped with 3.25 in. (83 mm) wide double-flanged wheels or cupped wheels for 2 in. (51 mm) pipe or urethane wheels for the 2000 Series Spanit®

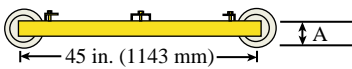

Dimension A - Height from approximately 4 in. (102 mm) up to 5 in. (127 mm) depending on type of wheel used

Non-powered trolley, equipped with 3.25 in. (83 mm) wide double-flanged wheels or cupped wheels for 2 in. (51 mm) pipe or urethane wheels for the single-line and double-line 1000 Series Spanit® and single-line 2000 Series Spanit®

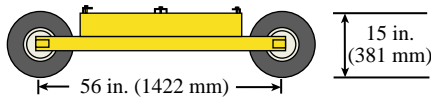

Non-powered trolley, equipped with 15 in. (381 mm) diameter rubber flotation tires for both the 1000 Series and 2000 Series Spanit®

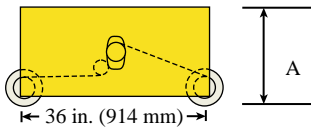

Dimension A - Height from approximately 18 in. (457 mm) up to 19 in. (483 mm) depending on type of wheel used

Hydraulically powered trolley, equipped with 3.25 in. (83 mm) wide double-flanged wheels or cupped wheels for 2 in. (51 mm) pipe or urethane wheels for both the 1000 Series and 2000 Series Power Spanit®

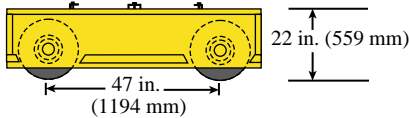

Non-powered trolley, equipped with 20 in. (508 mm) diameter rubber flotation tires for the single-line 4000 Series Spanit® and for the 1000 and 2000 Series Spanit®

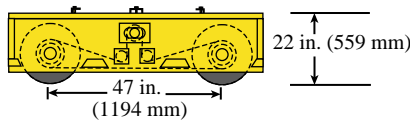

Hydraulically powered trolley with 20 in. (508 mm) diameter rubber flotation tires for the single-line 4000 Series Power Spanit® and for the single-line and double-line 1000 and 2000 Series Power Spanit®

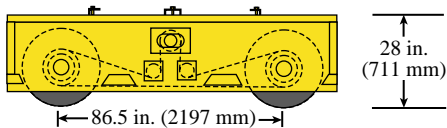

Hydraulically powered trolley with 26 in. (660 mm) diameter heavy-duty rubber flotation tires for the single-line 6000 Series Power Spanit® and for the double-line 4000 Series Power Spanit®

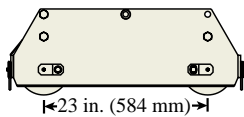

Non-powered trolley, equipped with 3.25 in. (83 mm) wide double-flanged wheels or cupped wheels for 2 in. (51 mm) pipe or urethane wheels for the 4000 and 6000 Series Spanit®

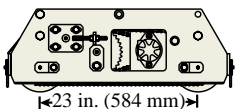

Hydraulically powered trolley, equipped with 3.25 in. (83 mm) wide double-flanged wheels or cupped wheels for 2 in. (51 mm) pipe or urethane wheels for the 4000 and 6000 Series Power Spanit®

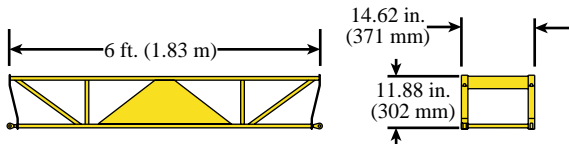

1000 Series Spanit®, durable lattice-type construction of tubular steel with plywood or expanded steel decking, available in 3 ft. (.91 m) @ 32 lbs. (14.5 kg), 6 ft. (1.83 m) @ 65 lbs. (29.5 kg) and 12 ft. (3.66 m) @ 120 lbs. (54.4 kg) sections.

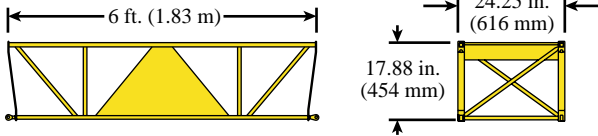

2000 Series Spanit®, durable lattice-type construction of tubular steel with plywood or expanded steel decking, available in 3 ft. (.91 m) @ 60 lbs. (27.2 kg), 6 ft. (1.83 m) @ 100 lbs. (45.4 kg) and 12 ft. (3.66 m) @ 195 lbs. (88.5 kg) sections. Telescoping insert from 12 to 18 ft. (3.66 to 5.49 m) @ 565 lbs. (256.3 kg) available.

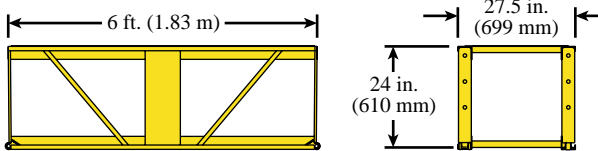

4000 Series Spanit®, durable lattice-type construction of tubular and sheet steel with expanded steel decking, available in 4 ft. (1.22 m) @ 151 lbs. (68.5 kg), 6 ft. (1.83 m) @ 192 lbs. (87.1 kg), 8 ft. (2.44 m) @ 249 lbs. (112.9 kg) and 12 ft. (3.66 m) @ 347 lbs. (157.4 kg) sections.

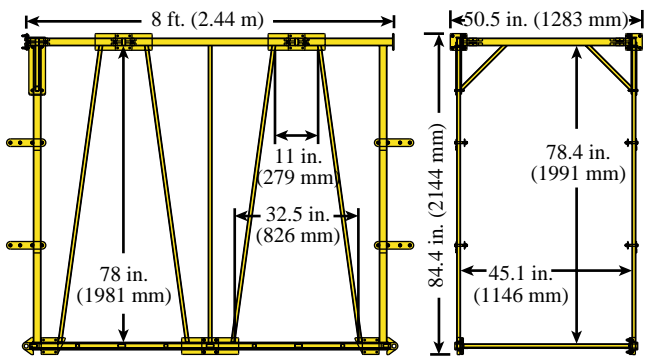

6000 Series Spanit®, durable lattice-type construction of square and rectangular tubular steel, with expanded steel decking, available in 2 ft. (.61 m) @ 191 lbs. (86.6 kg), 4 ft. (1.22 m) @ 280 lbs. (127 kg), 8 ft. (2.44 m) @ 484 lbs. (219.5 kg) and 12 ft. (3.66 m) @ 577 lbs. (261.7 kg) sections.

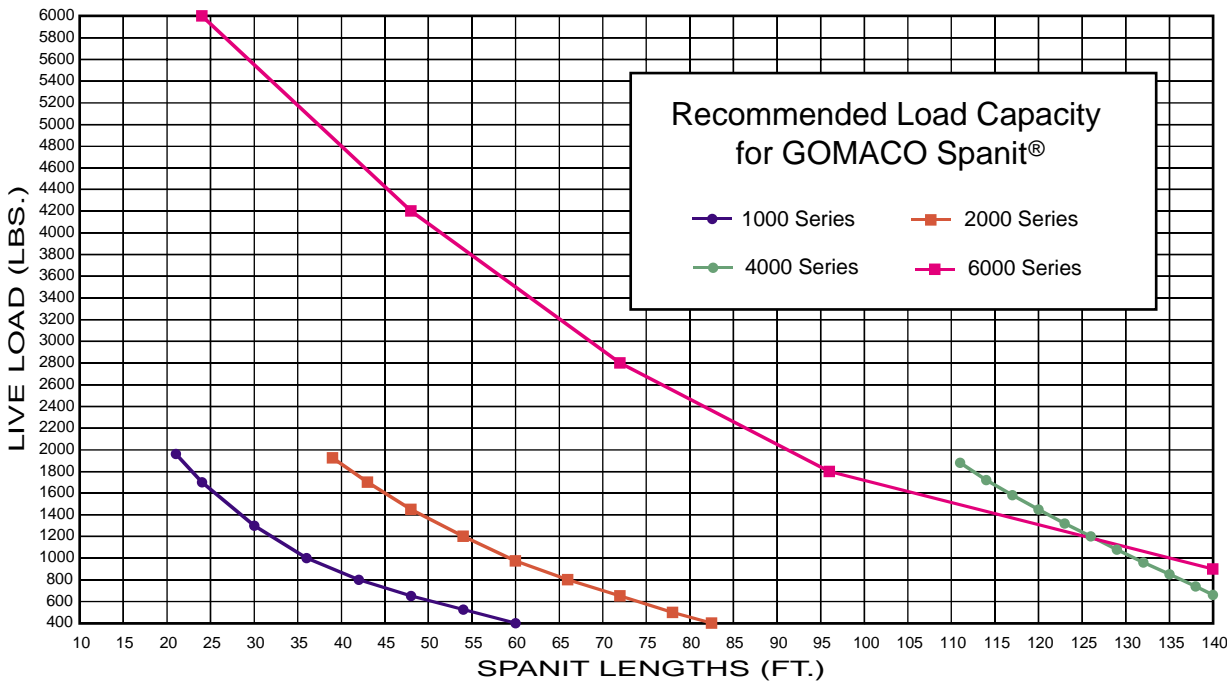

Maximum Widths with Live Loads

- 1000 Series Spanit®
60 ft. (18.29 m) @ 400 lbs. (181.4 kg)
- 2000 Series Spanit®
82.5 ft. (25.15 m) @ 400 lbs. (181.4 kg)
- 4000 Series Spanit®
140 ft. (42.67 m) @ 660 lbs. (299.4 kg)
- 6000 Series Spanit®
140 ft. (42.67 m) @ 900 lbs. (408.2 kg)

[NOTE - SPANIT® IS NOT RECOMMENDED FOR USE AS SCAFFOLDING]

MANUFACTURED UNDER ONE OR MORE OF THE FOLLOWING U.S. OR FOREIGN PATENTS: 3,299,786; 3,450,011; 3,541,931; 3,779,661; 3,959,977; 4,073,592; 4,136,993; 4,226,917; 4,343,513; 4,360,293; D-266,850; 853,607; 861,819; 954,773; 406,787; 1,147,187; 133,220; D-512,249; 4,717,282; 4,457,645; C-1,110,893; C-1,191,044; 12,890-1-0010; 5,061,115; 7,509,187; 7,509,615; 5,102,267; 5,101,360; 4,954,019; 4,984,639; 5,190,397; 5,209,602; 0518535; 2067126; 494,257; 69,031,836.7-08 AND PATENTS PENDING.



GOMACO Corporation reserves the right to make improvements in design, material, and/or changes in specifications at any time without notice and without incurring any obligation related to such changes.

Printed in U.S.A. © 1998 (4 AP)
GOMACO Corporation Order #0399-0A10314

GOMACO International
GOMACO Corporation
Ida Grove, Iowa USA 51445
Phone: 1-712-364-3347
Fax: 1.712.364.3986
E-Mail: info@gomaco.com
www.gomaco.com

GOMACO International LTD.
769 Buckingham Avenue
Trading Estate, Slough
SL1 4NL Berkshire, England
Phone: 44-1753-821926
Fax: 44.1753.693093

Singapore Representative Office
02-02 Heritage Apt.
4 Ardmore Park
Singapore 259960
Phone: 65-738-8481
Fax: 65.235.6837
E-Mail: tnash@pacific.net.sg